



LINEATOR™

Patented
Revolutionary New Reactor Design

Advanced Universal Harmonic Filter

'Wide Spectrum Harmonic Filter' for treatment of all harmonics generated by 3-phase diode or thyristor bridge rectifiers

Frees up system capacity by restoring VSD to near unity power factor



The most energy efficient harmonic solution for VSD's



Low capacitive reactance ensures generator compatibility

Meets harmonic limits for both land and marine VSD applications



Advanced Universal Harmonic Filter (AUHF)

The evolution of microprocessor based power electronic Variable Speed Drives (VSD) has progressed very rapidly over the past 20 years. With this growth has come concern over the level of current harmonics generated by these nonlinear loads. Harmonic currents increase losses, overheat electrical equipment and interact with the distribution system impedances causing voltage distortion which can have a detrimental effect on all equipment connected to the system.

Present methods of harmonic treatment (line reactors, multi-pulse systems, tuned or broadband passive filters, active filters and active-front-end drives) are often very large, unreliable, moderately effective, inefficient or too expensive.

The LINEATOR Advanced Universal Harmonic Filter (AUHF) is a revolutionary advance in the area of passive harmonic mitigation. No other device on the market can meet the stringent limits of IEEE Std 519 at an equivalent efficiency, size and cost.

When your application calls for a truly cost effective harmonic solution, the LINEATOR AUHF is the logical choice. It provides Engineers with a standard off-the-shelf solution for what used to be a very challenging engineering problem.

Features

Wide Spectrum Harmonic Filter treats all major harmonics generated by VSD's and other 3-phase rectifier loads

Saves energy by reducing upstream harmonic losses while operating at >99% efficiency

Guaranteed to meet IEEE Std 519 for both current and voltage distortion at the input terminals of the LINEATOR

Total Demand Distortion (TDD) of the current at the LINEATOR input terminals will not exceed the limits as defined in Table 10.3 of IEEE Std 519

Compatible with engine driven generators thanks to the extremely low capacitive reactance, even at no load

Low capacitive reactance also eliminates the need for capacitor switching contactors (contactors are available upon request)

Power factor 0.95 leading to 0.98 lagging over the normal operating range (40 to 100% load)

Will not resonate with other power system components or attract line side harmonics

Suppresses overvoltages caused by commutation notching, capacitor switching and other fast changing loads

Removal of harmonics improves overall system power factor

Suitable for application on multiple VSD's provided only VSD's are connected

Reduces conducted RF interference generated by VSD

Models available for AC Drives and DC Drives or other controlled rectifiers

18-Pulse Performance from standard 6-Pulse Variable Speed Drives

Up to 3% more energy efficient than 18-Pulse solutions

Will meet IEEE 519 standard for both current and voltage distortion

ABS Type Approved for marine applications



Apply LINEATOR anywhere Variable Speed Drives and 6-Pulse Rectifiers are used

- Oil and Gas industry
- Water and Waste Water
- Irrigation systems
- HVAC systems
- Mining operations
- Marine vessels
- Printing presses
- Elevators and escalators
- Pulp and paper processing

Other applications include:

- Induction furnaces
- Industrial rectifiers
- Welding operations



Advantages of the LINEATOR over other Passive Filters

The LINEATOR is a purely passive device consisting of a revolutionary new inductor combined with a relatively small capacitor bank. It's innovative design achieves reduction of all the major harmonic currents generated by VSD's and other similar 3-phase, 6-pulse rectifier loads. The resulting I_{THD} is reduced to <8% and often as low as 5%. Although referred to as a filter, the LINEATOR exhibits none of the problems that plague conventional filters.

Harmonic Distortion Reduction

The filtering effectiveness of a trap filter is dependent upon the amount of harmonics present at untuned frequencies as well as the residual at the tuned frequency. To obtain performance better than 15% I_{THD}, multiple tuned branches are often required. Other broadband filters require relatively large capacitor banks (2 to 3 times more than Lineator) to achieve reasonable performance.

Harmonics from other sources

As a parallel connected device, the conventional trap filter has no directional properties. It therefore, can easily be overloaded by attracting harmonics from upstream non-linear loads. The LINEATOR, on the other hand, will present a high impedance to line side harmonics eliminating the possibility of inadvertent importation and overloading.

System Resonance

At frequencies below its tuned frequency, a conventional filter will appear capacitive. This capacitance has the potential of resonating with the power systems natural inductance. When a filter is tuned to a higher order harmonic, such as the 11th, it could easily resonate at a lower harmonic frequency, such as the 5th or 7th. The natural resonance frequency of the LINEATOR is below that of any predominant harmonic, therefore inadvertent resonance is avoided.

Capacitive Reactance and Leading Power Factor

The large capacitor banks in trap filters and competing broadband filters present a high capacitive reactance to the system, especially under light loads. On weak power systems, this can raise voltages or cause excitation control problems in generator applications. To address this, some filter manufacturers offer mechanisms for switching out the capacitors under light loads, increasing cost and complexity. This is not necessary for the LINEATOR because even under no load conditions, it's capacitive reactance (kVAR) remains below 15% of its kVA rating. This ensures compatibility with engine generators, without the need to switch out capacitors.

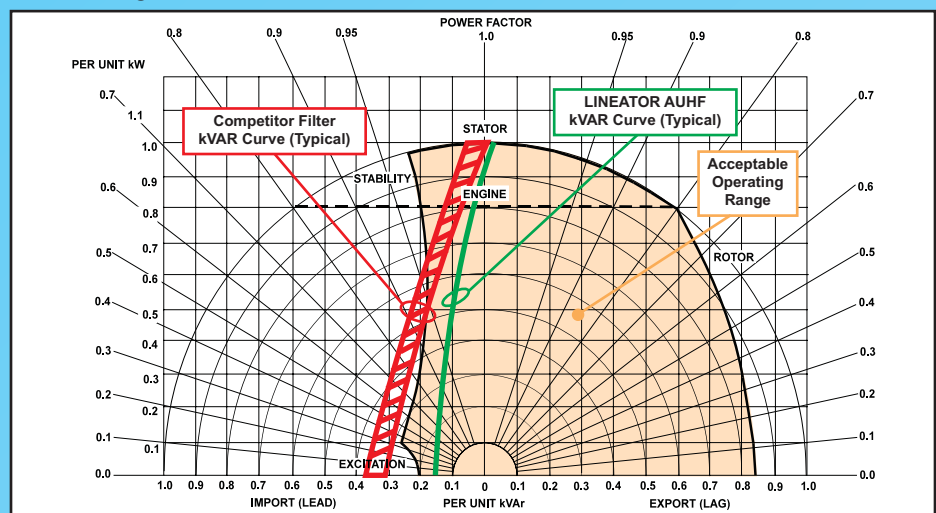

Generator Reactive Power Capability Curve

Performance

Compare Performance!

The LINEATOR outperforms all other forms of VSD harmonic solutions. By choosing the LINEATOR you have selected a filter that:

- performs in Real World environments even with background voltage distortion and voltage imbalance
- lowers operating costs by being highly efficient
- is compatible with engine generators and incorporates a low capacitive reactance design
- has a simple and compact design to reduce footprint and ensure reliability
- can be computer modeled to provide up front assurance of meeting harmonic limit standards such as IEEE Std 519, ABS and other marine certifying bodies
- is factory performance tested under actual VSD loading

Efficiency Comparison

The unique design of the AUHF produces extremely low losses. It's operating efficiency therefore is much higher than competitive filters. The graphs below show typical losses and efficiencies for AUHF and two competitors. (AUHF is available in sizes up to 3500HP. Since competitor maximum sizes are only 600HP and 900HP, the chart range has been set at 1000HP)

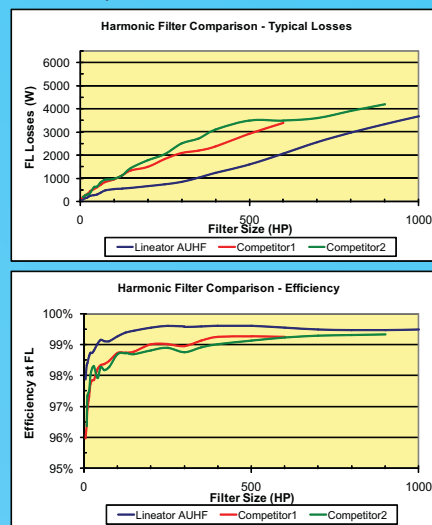

Improves VSD Performance

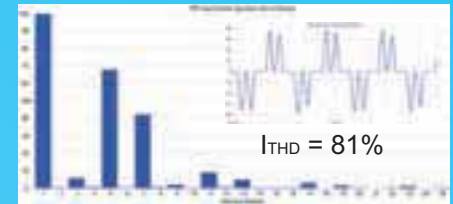

VSD Input Current Waveform and Spectrum with no reactor.

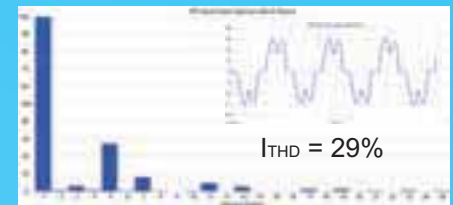

VSD Input Current Waveform and Spectrum with AC reactor.

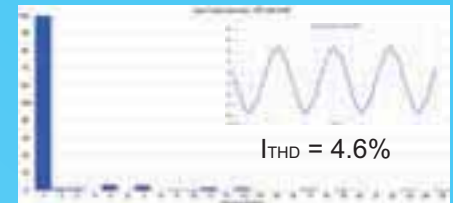

VSD Input Current Waveform and Spectrum with LINEATOR AUHF.

Outperforms 18-P Solutions

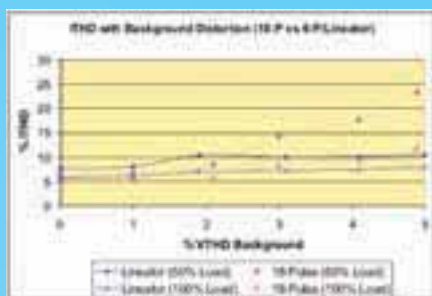

As background voltage distortion increases, the harmonic mitigating performance of the 18-Pulse VSD degrades much quicker than the 6-Pulse / LINEATOR combination. This demonstrates that the LINEATOR AUHF will not attract harmonic currents as other non-linear loads distort the applied voltage waveform. LINEATOR is the only harmonic solution that guarantees performance even in heavily distorted environments.

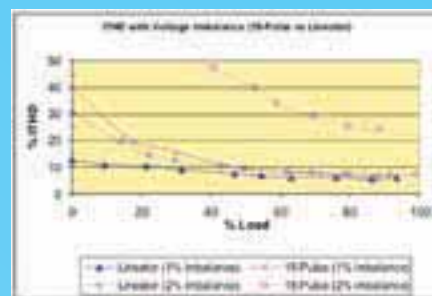

There is little degradation in harmonic mitigating performance of the 6-Pulse / LINEATOR combination as voltage imbalance increases. The 18-Pulse solution, on the other hand, degrades dramatically because harmonic cancellation due to phase shifting becomes much less effective with 3-phase voltage imbalance.

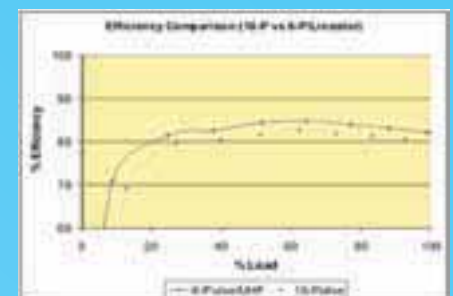

The 6-Pulse VSD / LINEATOR combination has 2% to 3% higher efficiency than the 18-Pulse solution over the entire operating range. (Efficiency shown is for a system that includes motor/gen set load, VSD, and harmonic mitigation equipment). When compared to an 18-Pulse VSD, a 400HP AUHF/VSD will save more than \$3,000 in annual operating costs when averaging 75% loading at \$0.07/kWhr.

H&E LAB™

The Harmonics & Energy (H&E) Lab at MIRUS International Inc. provides the unique ability to test our products under 'real world' non-linear load conditions. We also conduct compatibility testing with all major VSD manufacturers' products to ensure a trouble-free installation.



Every LINEATOR is factory tested under VSD load to ensure our performance guarantee is met. No other manufacturer provides this level of testing whether they offer a passive filter, multi-pulse or active solution.



SOLV™

Simulation of LINEATOR / VFD

MIRUS offers proprietary software called Simulation of LINEATOR / VFD (SOLV). SOLV is a powerful and unique computer simulation program that will calculate current and voltage distortion levels based on your load requirements.

By simply entering some basic information about your source and VSD system, you can generate very useful reports such as, an IEEE 519 Compliance Report. In addition to the accurate reports, you can print a single line representation of your system along with voltage and current waveforms and spectrums.

MIRUS' SOLV will help you find the right solution for your VSD application without the need of a costly harmonic study. It can be downloaded at mirusinternational.com

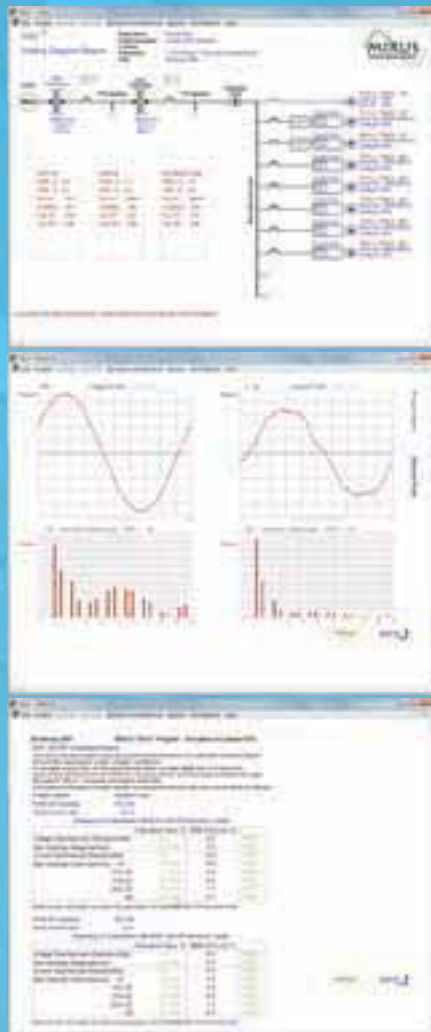

'Performance Guarantee'

MIRUS guarantees that the LINEATOR AUHF will perform as advertised to reduce harmonic distortion caused by AC Variable Speed Drives and other non-linear loads equipped with 3-phase, 6-pulse, diode bridge rectifiers. A properly selected and installed LINEATOR will:

Reduce Current Total Harmonic Distortion (ITHD), measured at the LINEATOR input terminals at full load, to:

- (i) <8% when background voltage distortion is <5% and voltage imbalance is <3%
- (ii) <5% when short circuit ratio (I_{sc}/I_L), as defined by IEEE Std 519, is <20 and when background voltage distortion is <0.5% and voltage imbalance is <1%
- (iii) Reduce Current Total Demand Distortion (ITDD), measured at the LINEATOR input terminals over its entire operating range, to levels defined in Item (i) above. ITDD is defined as the ratio of ITHD divided by the full load current (peak demand current) of the LINEATOR.
- (iv) Minimize the contribution to Voltage Harmonic Distortion of all VSD's equipped with the LINEATOR to <5% total and <3% for individual harmonics, as defined by IEEE Std 519-1992.
- (v) NOT become overloaded by other upstream harmonic sources.
- (vi) NOT resonate with other power system components.
- (vii) NOT have compatibility problems with engine generator sets properly sized for the load.



General Specifications:

HP / kW RATING:

Available for motor/drive system sizes up to 3500HP / 2600kW

VOLTAGE:

Standard voltages up to 690V, 3-phase

FREQUENCY:

50 or 60Hz

OVERLOAD CAPABILITY:

Suitable for overload of 150% for 60 seconds every 10 minutes

HARMONICS TREATED:

5th, 7th, 11th, 13th, ...

K-FACTOR SUITABILITY:

Up to 20

INPUT K-FACTOR:

Reduced to <1.5

INPUT CURRENT DISTORTION:

<8% at full load

NO LOAD CAPACITIVE REACTANCE (kVAR) LEVELS:

5 to 75HP 15 to 20%
100 to 3500HP 10 to 15%

EFFICIENCY:

>99%

ELEVATION:

3300ft [1000m] above sea level

VENTILATION:

Convection air cooled

ENCLOSURE:

NEMA 3R [IP23]
Paint: Polyester powder coated
Color: ANSI 61 Grey

OPTIONS:

Nema 3R [IP23] Enhanced
ABS, DNV or Lloyds Certification

Typical LINEATOR Applications

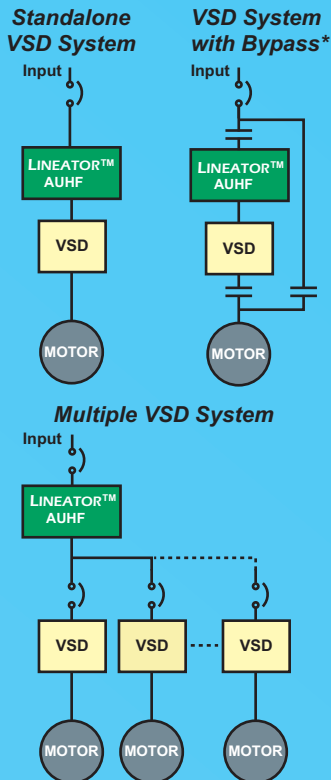

* When the VSD requires a bypass, the LINEATOR must also be bypassed as shown.

Rating Tables: (type 'D' Lineator)^[1]

Motor Size		Lineator Rating				208V (50 or 60Hz), 240V (50Hz)				400, 440V (50Hz)								
HP	kW	Input Amps (3-Phase)			Output kW	Standard Enclosure		Enhanced Enclosure		Standard Enclosure		Enhanced Enclosure						
		220/240V	380/400V	415/440V		Case Style	Weight lbs [kg]	Case Style	Weight lbs [kg]	Case Style	Weight lbs [kg]	Case Style	Weight lbs [kg]					
5	4	14	13	8	7	4.5	SU1	65 [30]	SU1-E	75 [34]	SU1	58 [26]	SU1-E	68 [31]				
7.5	5.5	20	18	11	10	6.3	SU2	76 [35]	SU2-E	86 [39]	SU2	67 [30]	SU2-E	77 [35]				
10	7.5	27	24	14	13	8.5		80 [36]		80 [36]		78 [35]		88 [40]				
15	11	40	36	21	19	13		117 [53]		127 [58]		90 [41]		100 [45]				
20	15	53	48	28	25	17	SU3	138 [63]	SU3-E	148 [67]	SU3	118 [54]	SU3-E	128 [58]				
25	18.5	66	60	35	32	21		154 [70]		164 [74]		130 [59]		140 [64]				
30	22	79	72	42	38	25	SU3	189 [86]	SU3-E	199 [90]	SU3	142 [65]	SU3-E	152 [69]				
40	30	105	95	55	51	34		253 [115]		263 [119]		154 [70]		164 [74]				
50	37.5	131	119	69	63	42		275 [125]		333 [151]		186 [84]		196 [88]				
60	45	158	143	83	76	51	MT2	315 [143]	MT2-E	337 [153]	MT2	218 [99]	MT2-E	228 [103]				
75	55	196	178	103	95	63		325 [148]		399 [181]		304 [138]		314 [142]				
100	75	260	236	137	125	84	MT2	442 [201]	MT3-E	516 [235]	MT2	323 [147]	MT2-E	414 [188]				
125	90	323	294	170	156	104		468 [213]		542 [246]		345 [156]		354 [159]				
150	110	388	353	204	187	125	MT3	553 [251]	MT3-E	627 [285]	MT3	365 [166]	MT3-E	469 [213]				
200	150				274	250		168		MT4		MT4-E			MT4	415 [189]	MT4-E	514 [234]
250	185				340	312		209								578 [262]		600 [273]
300	200				410	374	251	585 [266]	670 [305]									
350	250				475	436	292	LT1	LT1-E		LT1	800 [363]	LT2-E	1006 [456]				
400	315				565	520	349					825 [374]		1031 [467]				
500	400				720	660	443	LT2	LT2-E		LT2	915 [415]	LT3-E	1121 [508]				
600	450				810	740	499					1098 [499]		1176 [535]				
700	500				940	865	579					1700 [771]		1839 [834]				
800	560				1075	985	662	LT3	LT3-E		LT3	1882 [854]	HT2-E	1954 [886]				
900	630				1200	1100	736					1920 [871]		2054 [931]				
1000	710				1335	1220	818	HT2	HT2-E		HT2	1950 [884]	HT3-E	2084 [945]				
1100	800				1470	1340	900					2465 [1118]		2564 [1163]				
1200	900				1610	1470	987					2568 [1167]		2958 [1245]				
1300	970				1735	1585	1064	HT3	HT3-E		HT3	2718 [1236]		3408 [1549]				
1400	1000				1870	1710	1145					2858 [1299]		3548 [1613]				
1500	1120				2000	1835	1228					3598 [1635]		3690 [1677]				
1600	1200				2145	1965	1316	HT3	HT3-E		HT3	3748 [1703]		3840 [1745]				
1800	1350				2410	2210	1481					3848 [1749]		4376 [1943]				
2000	1450				2670	2440	1636	HT3	HT3-E		HT3	3978 [1808]		4506 [2048]				
2300	1700				3065	2810	1882					4075 [1850]		4600 [2088]				
2500	1850				3335	3050	2045	HT3	HT3-E		HT3	4650 [2111]		4750 [2157]				
2800	2100				3750	3435	2303					5000 [2270]		5100 [2315]				
3000	2250				4020	3680	2468					5225 [2372]						
3500	2600				4265	3905	2618	5550 [2520]										

Motor Size		Lineator Rating				480V (60Hz), 600V / 690V (50Hz)				600V / 690V (60Hz)				
HP	kW	Input Amps (3-Phase)			Output kW	Standard Enclosure		Enhanced Enclosure		Standard Enclosure		Enhanced Enclosure		
		460/480V	575/600V	660/690V		Case Style	Weight lbs [kg]	Case Style	Weight lbs [kg]	Case Style	Weight lbs [kg]	Case Style	Weight lbs [kg]	
5	4		7	5	5	4.5	SU1	58 [26]	SU1-E	68 [31]	SU1	57 [26]	SU1-E	67 [30]
7.5	5.5		9	7	6	6.3		67 [30]		77 [35]		67 [30]		77 [35]
10	7.5		12	10	8	8.5		78 [35]		88 [40]		77 [35]		87 [39]
15	11		17	14	12	13	SU2	90 [41]	SU2-E	100 [45]	SU2	86 [39]	SU2-E	96 [44]
20	15		23	18	16	17		118 [54]		128 [58]		98 [45]		128 [58]
25	18.5		29	23	20	21		130 [59]		140 [64]		125 [57]		135 [61]
30	22		34	28	24	25	SU3	142 [65]	SU3-E	152 [69]	SU3	137 [62]	SU3-E	147 [67]
40	30		46	37	32	34		154 [70]		164 [74]		149 [68]		159 [72]
50	37.5		57	45	40	42	SU3	186 [84]	SU3-E	196 [89]	SU3	184 [83]	SU3-E	196 [89]
60	45		69	55	48	51		218 [99]		228 [103]		206 [94]		216 [98]
75	55		85	68	59	63		304 [138]		314 [142]		298 [135]		308 [140]
100	75		113	90	79	84	MT2	323 [147]	MT2-E	333 [151]	MT2	315 [143]	MT2-E	325 [147]
125	90		141	112	98	104		345 [156]		419 [191]		345 [156]		419 [191]
150	110		169	135	118	125	MT3	365 [166]	MT3-E	439 [200]	MT3	365 [166]	MT3-E	439 [200]
200	150		226	180	158	168		415 [189]		489 [222]		415 [189]		489 [222]
250	185		281	225	196	209	MT4	578 [262]	MT4-E	640 [290]	MT4	578 [262]	MT4-E	640 [290]
300	200		337	270	235	251		585 [266]		695 [316]		585 [266]		695 [316]
350	250		395	315	275	292		800 [363]		1006 [456]		780 [354]		1006 [456]
400	315		470	375	325	349	LT1	825 [374]	LT1-E	1031 [467]	LT1	805 [365]	LT1-E	1031 [467]
500	400		595	475	415	443		915 [415]		1121 [508]		915 [415]		1121 [510]
600	450		670	535	470	499	LT2	1398 [634]	LT2-E	1476 [670]	LT2	1398 [634]	LT2-E	1476 [670]
700	500		780	625	545	579		1700 [771]		1839 [834]		1650 [748]		1740 [789]
800	560		890	715	620	662		1882 [854]		1954 [886]		1805 [819]		1852 [842]
900	630		990	795	690	736	LT3	1920 [871]	LT3-E	2054 [931]	LT3	1882 [854]	LT3-E	2054 [932]
1000	710		1100	880	770	818		1950 [884]		2084 [945]		1915 [869]		2064 [936]
1100	800		1210	970	845	900	HT2	2465 [1118]	HT2-E	2564 [1163]	HT2	2331 [1057]	HT2-E	2515 [1141]
1200	900		1330	1060	925	987		2718 [1236]		2958 [1245]		2609 [1186]		2855 [1298]
1300	970		1430	1145	1000	1064		3408 [1549]		3548 [1613]		2782 [1265]		3172 [1442]
1400	1000		1540	1235	1075	1145	HT2	2858 [1299]	HT3-E	3548 [1613]	HT2	2858 [1299]	HT3-E	3172 [1442]
1500	1120		1650	1325	1155	1228		3598 [1635]		3690 [1677]		3540 [1606]		3620 [1642]
1600	1200		1770	1415	1235	1316	HT3	3748 [1703]	HT3-E	3840 [1745]	HT3	3702 [1679]	HT3-E	3800 [1724]
1800	1350		1990	1595	1390	1481		3848 [1749]		4376 [1943]		3798 [1723]		3875 [1758]
2000	1450		2200	1765	1535	1636		3978 [1808]		4506 [2048]		3945 [1789]		4250 [1928]
2300	1700		2530	2030	1765	1882	HT3	4075 [1850]	HT3-E	4600 [2088]	HT3	4015 [1821]	HT3-E	4340 [1969]
2500	1850		2755	2205	1920	2045		4650 [2111]		4750 [2157]		4600 [2087]		4750 [2155]
2800	2100		3100	2480	2160	2303	HT3	5000 [2270]	HT3-E	5100 [2315]	HT3	4945 [2243]	HT3-E	5100 [2313]
3000	2250		3320	2660	2315	2468		5225 [2372]				5180 [2350]		
3500	2600		3855	3085	2685	2618		5550 [2520]				5490 [2490]		

1. For type 'T' Lineator use enclosure and weights from the next size up.

Dimensions

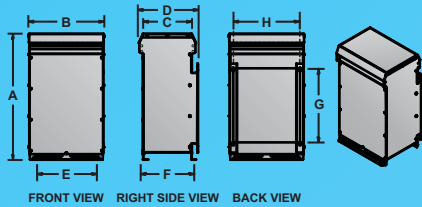

'SU' ENCLOSURE

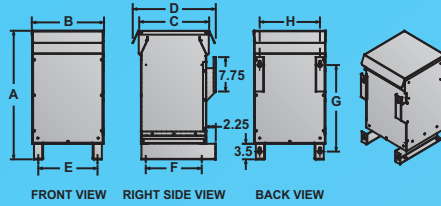

'MT1', 'MT2' ENCLOSURE

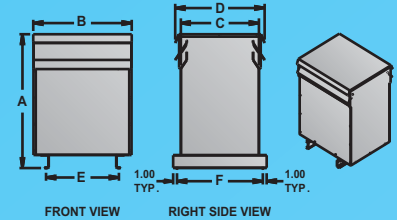

'MT3', 'MT4', 'LT' ENCLOSURE

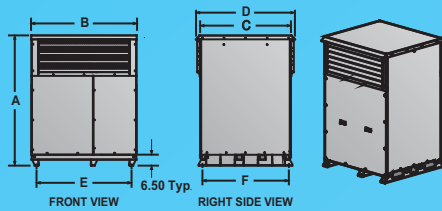

'HT' ENCLOSURE

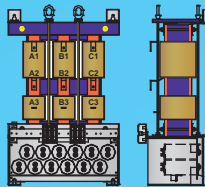

'E0P' PANEL MOUNT

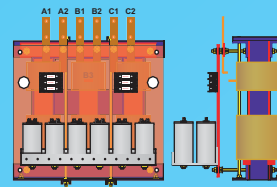

'E0' OPEN STYLE

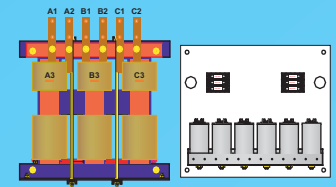

'E0M' MODULAR

CASE STYLE		DIMENSIONS - inches [mm]							
Standard	Enhanced	A	B	C	D	E	F	G	H
SU1	SU1-E	23.50 [597]	11.25 [286]	8.75 [222]	11.25 [286]	8.00 [203]	9.00 [229]	13.00 [330]	9.00 [229]
SU2	SU2-E	29.50 [749]	13.25 [336]	10.25 [260]	12.75 [324]	9.00 [229]	10.00 [254]	19.00 [483]	11.00 [279]
SU3	SU3-E	34.00 [864]	20.25 [514]	13.25 [336]	16.00 [406]	17.50 [445]	13.00 [330]	20.00 [508]	18.00 [457]
MT2	MT2-E	38.00 [965]	21.50 [546]	19.50 [495]	23.50 [597]	17.00 [432]	17.50 [445]	25.00 [635]	
MT3	MT3-E	45.00 [1143]	26.00 [661]	21.00 [534]	25.00 [635]	21.50 [546]	19.00 [483]		
MT4	MT4-E	51.50 [1308]	32.00 [813]	25.50 [648]	29.50 [749]	23.50 [597]	23.50 [597]		
LT1	LT1-E	59.00 [1499]	39.50 [1003]	30.00 [762]	34.00 [864]	24.00 [610]	32.00 [813]		
LT2	LT2-E	66.00 [1677]	44.00 [1118]	34.00 [864]	38.00 [965]	26.00 [660]	36.00 [915]		
LT3	LT3-E	75.00 [1905]	48.50 [1232]	39.00 [991]	43.00 [1092]	27.50 [699]	41.00 [1041]		
HT2	HT2-E	78.00 [1981]	58.50 [1486]	51.00 [1295]	56.25 [1428]	52.50 [1333]	50.75 [1289]		
HT3	HT3-E	84.00 [2134]	68.50 [1740]	59.00 [1499]	64.50 [1638]	62.50 [1587]	58.75 [1492]		

Ordering Information

Model	Motor Horsepower	Line Voltage	Frequency	Load Type	Enclosure Type	Optional
AUHF	HP	VVV	Hz	L	En	O
Advanced	5	208	50	D ^[1]	E0	E
Universal	to	240	60	Diode Bridge	No Enclosure (250 to 3500HP)	Nema 3R
Harmonic	3500	400		Rectifier	EOP	[IP23]
Filter		440		T ^[2]	Panel Mount (5 to 200HP)	Enhanced
		480		Thyristor Bridge	EOM	
		600		Rectifier	Modular (250 to 3500HP)	
		690			E1	
		(VAC)			Nema 3R [IP23]	
					Ventilated (5 to 3500HP)	

1. 'D' type AUHF is suitable for standard diode bridge and diode/SCR precharged front-end VSD's.

2. 'T' type AUHF is suitable for DC drives, Current Source Inverters and other controlled rectifier loads.



Expect better. Call us.

To discuss how MIRUS can help you meet your power quality challenges, contact us at our head office:

MIRUS International Inc.
6805 Invader Cres., Unit #12
Mississauga, Ontario
Canada L5T 2K6

Tel: (905) 565-6900

Fax: (905) 565-6911

Toll-Free: 1-888-TO MIRUS (888-866-4787)

www.mirusinternational.com



Harmonic and Energy Solutions

Real-world performance
for real-world loads.



AUHF-PS01-A
Effective: August 2007